

CRAWLER EXCAVATOR

HX220A1



The HX220AL Crawler Excavator is part of Hyundai's brand new A-series: a fresh generation of construction equipment that complies with the European stage V emission levels. But it does much more than that! While fulfilling regulatory demands, Hyundai aimed for a ground-breaking level of customer satisfaction with maximum performance and productivity, better safety, more convenience and improved uptime management.

From its robust exterior design to its smart performance-enhancing technologies, the HX220AL opens up a world of new possibilities where tiny efforts move mountains. It's time to experience the Hyundai Effect!



READY TO CHANGE YOUR WORLD



ENTER A
WORLD WHERE
ANYTHING IS
POSSIBLE



Productivity

- Short cycle times
- Mono or two-piece boom
- Leading controllability with Electronic Pump Flow Control (EPFC)
- Customisable hydraulic attachment lines
- Attachment flow control (20 tools programmable)
- Fine swing control (option)
- Boom floating system (option)

Comfort

- Spacious cabin
- 8" touchscreen monitor
- Automatic climate control
- Smart key and start/stop button
- Air suspension seat with heater (option)
- Viscous cabin suspension mounts
- Ergonomic joystick design

Durability/Safety

- Excellent visibility
- AAVM camera system (option)
- LED lights (option)
- Reinforced upper and lower structure
- High-grade hoses
- Reinforced pins, bushings and polymer shims
- Swing lock (option)

Serviceability

- Excellent accessibility
- Electric Fuel Filter Pump with Automatic Stop Function
- Centralised greasing (option)
- Hi Mate telematic system
- Extended service intervals



POWERFUL AND FUEL-EFFICIENT TO BOOST PRODUCTIVITY

The HX220AL is powered by a robust Stage V-certified Cummins engine with an innovative integrated after-treatment system that reduces both emissions and maintenance requirements. It delivers all the power you need to handle demanding jobs, along with fast levelling and truck loading times and excellent fuel economy.

A range of smart technologies are included for precise management of the engine output and pump flow rate. A new EPFC (Electronic Pump Flow Control) system improves controllability and reduces operating costs. Additional control and monitoring features help you to further improve productivity every single day.

EPFC

Fuel Saving & Fine Control

EPFC (Electronic Pump Flow Control) improves the controllability of attachments, enabling faster, more precise work with optimised fine control. It also reduces fuel consumption by optimising pump output control for each operation.

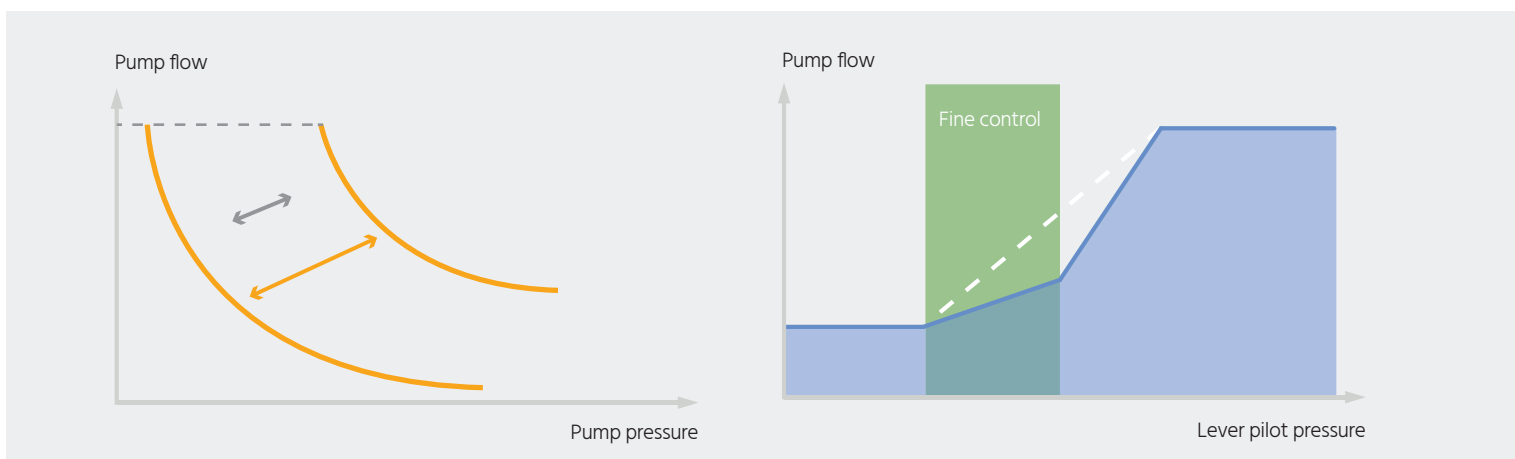

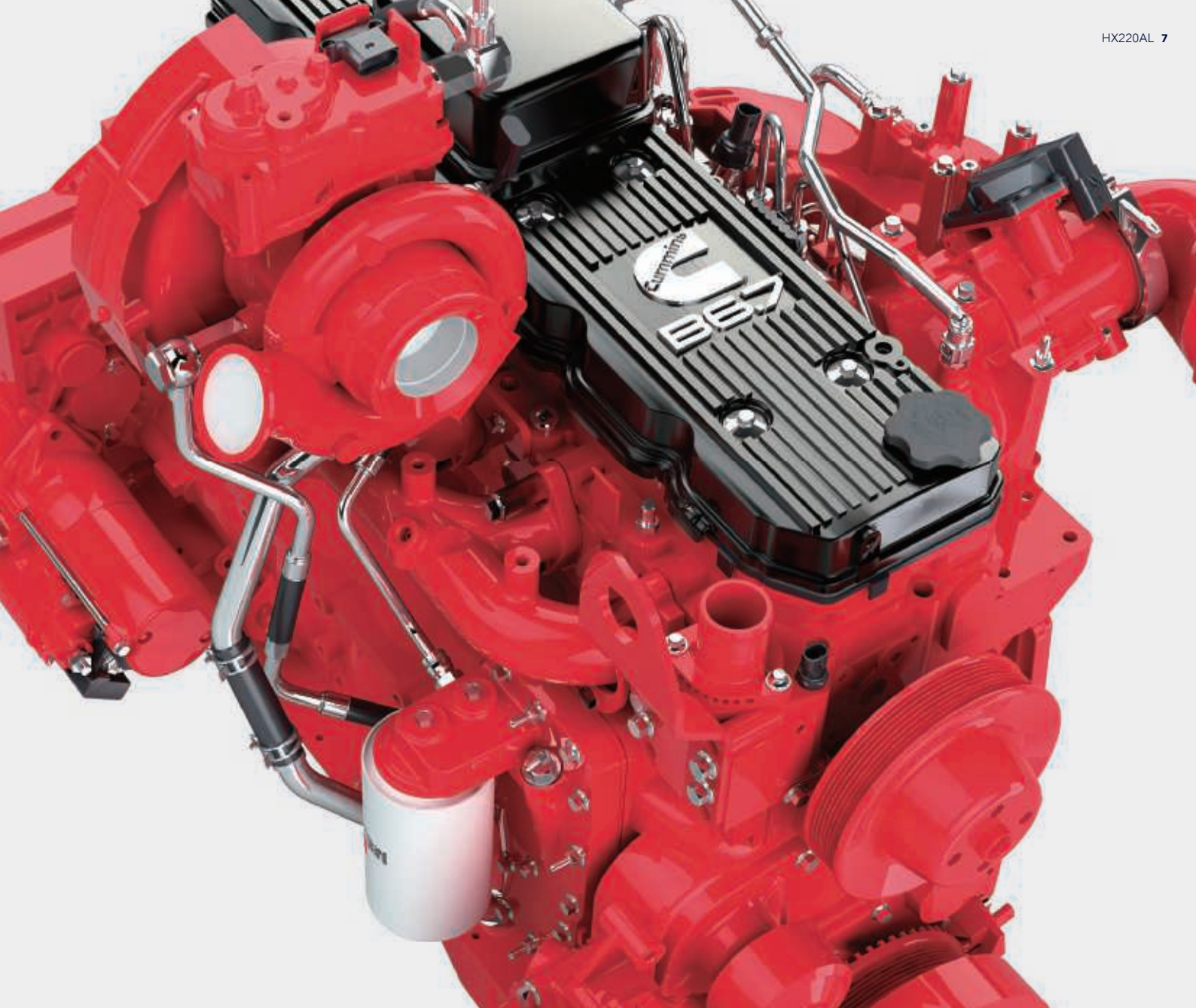

“The control technologies are well thought-out and save me time and money on every job.”

- ◀ The **combination speed setting system** allows operators to balance load sensitivity and boom priority against arm and swing. Select from five levels of load sensitivity to adjust initial flow rate for boom-up and arm-in operation according to attachment weight. Ten levels of boom priority can be selected to balance boom operation against arm and swing.

Like all A-Series machines, the HX220AL features our **all-in-one exhaust aftertreatment system** which cuts emissions and operating costs while enhancing reliability and simplifying maintenance.

- ▶ Easy-to-use **3D Machine Guidance** gives precise feedback on the bucket position as well as 3D grading assistance and jobsite mapping in real time. This reduces manpower requirements on site and enhances operator performance. The system includes an optional **Hyundai Ready automatic surveying system** for excavators which provides work guides to further improve work speed and productivity.



A CABIN DESIGNED AROUND YOU

The HX220AL cabin was designed as a comfortable working environment that enhances productivity and reduces fatigue for every operator. Pleasant and spacious, it features a high-quality, adjustable seat and comfortable reach to all controls. A range of technologies enable easier machine monitoring, while the audio system includes radio, USB and AUX input to keep you entertained during your working day. The overall design places you right at the centre of the Hyundai Effect, with a world of convenience and control at your fingertips.

"I can check the machine status anytime I want and adapt my performance for better, faster results. It's almost as if the machine has become an extension of me."





◀ The accelerator, remote air conditioner controller and instrument cluster can be operated using the convenient jog shuttle-type **haptic controller**.

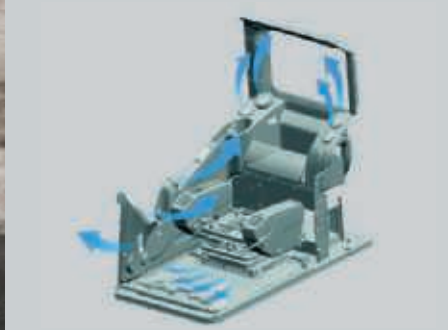
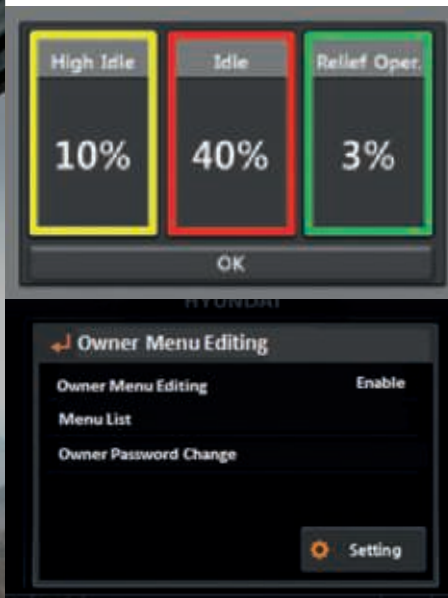

▶ The **Miracast system based on the operator's smartphone Wi-Fi** allows the use of various smartphone features on the screen, including navigation, web surfing and music and video playback.



▶ The **instrument panel** is optimised to provide quick, easy access to machine status information as you work. It features an 8-inch **touchscreen monitor** for excellent legibility.

◀ The **Eco Report** feature helps you to develop efficient working habits by displaying real-time information about machine performance.

◀ **Menu functions** can be set by the machine owner, who can also provide or restrict access for machine users by using a password to lock or unlock the list of machine parameters.

◀ The HX220AL has a luxurious **air suspension seat with heating** as standard. The **ergonomic joysticks** make operation comfortable and intuitive.

◀ The **heating and air conditioning** system efficiently regulates and directs airflow in the cabin.



SUPPORTING A SAFER WORKPLACE

Small details can make a huge difference when it comes to safety and security. The HX220AL offers all-round protection for you, your workmates and your equipment. Its cabin and engine hood feature a new design that allows maximum visibility, while Advanced Around View Monitoring (AAVM) gives you a clear overview of your surroundings. By helping to ensure an accident-free worksite, the HX220AL contributes to the peace of mind and productivity that form part of the Hyundai Effect.



The **Advanced Around View Monitoring (AAVM)** camera system gives you a 360° overview of your immediate working environment. It also includes Intelligent Moving Object Detection (IMOD) technology that senses and warns you when people or objects come within five metres of the machine.



The **open design of the cabin side door** gives the operator a clear, unimpeded view to the exterior. The **door handle** design has also been redesigned for more convenient access.



"I can always see what's going on around me, even when weather conditions are poor or the machine is moving."

The **auto safety lock** feature prevents unintentional ignition. While the auto safety lock is activated, the excavator is not controlled by the RCV lever.

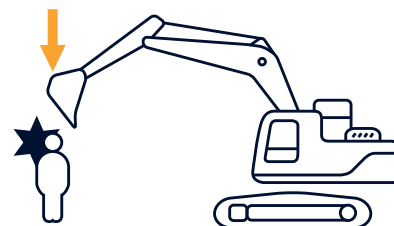
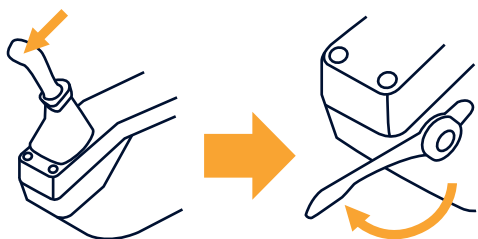

ADVANCED DIAGNOSTICS AND SERVICING SUPPORT

The peace of mind that comes with quick, low-effort servicing is also part of the Hyundai Effect. The HX220AL is designed to make maintenance as convenient as possible. All components and materials have been optimised to ensure a long, trouble-free life. Hyundai's Hi Mate remote management system uses mobile data technology to provide the highest level of service and support. The HX220AL also features our new Engine Connected Diagnostics (ECD) system which immediately reports any engine failure to both Hi Mate and the engine manufacturer to ensure the fastest, easiest resolution.

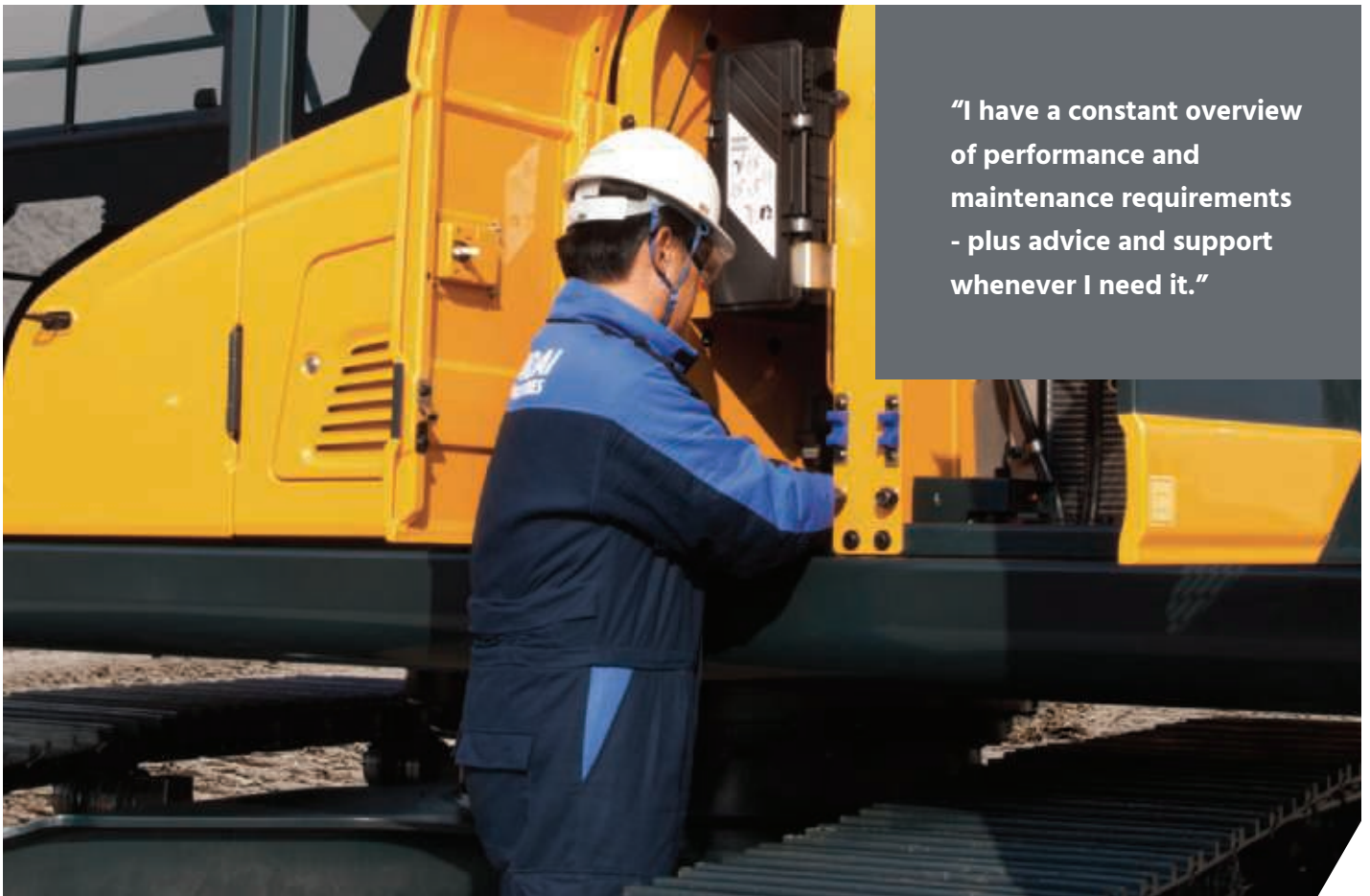

"I have a constant overview of performance and maintenance requirements - plus advice and support whenever I need it."

HiMATE

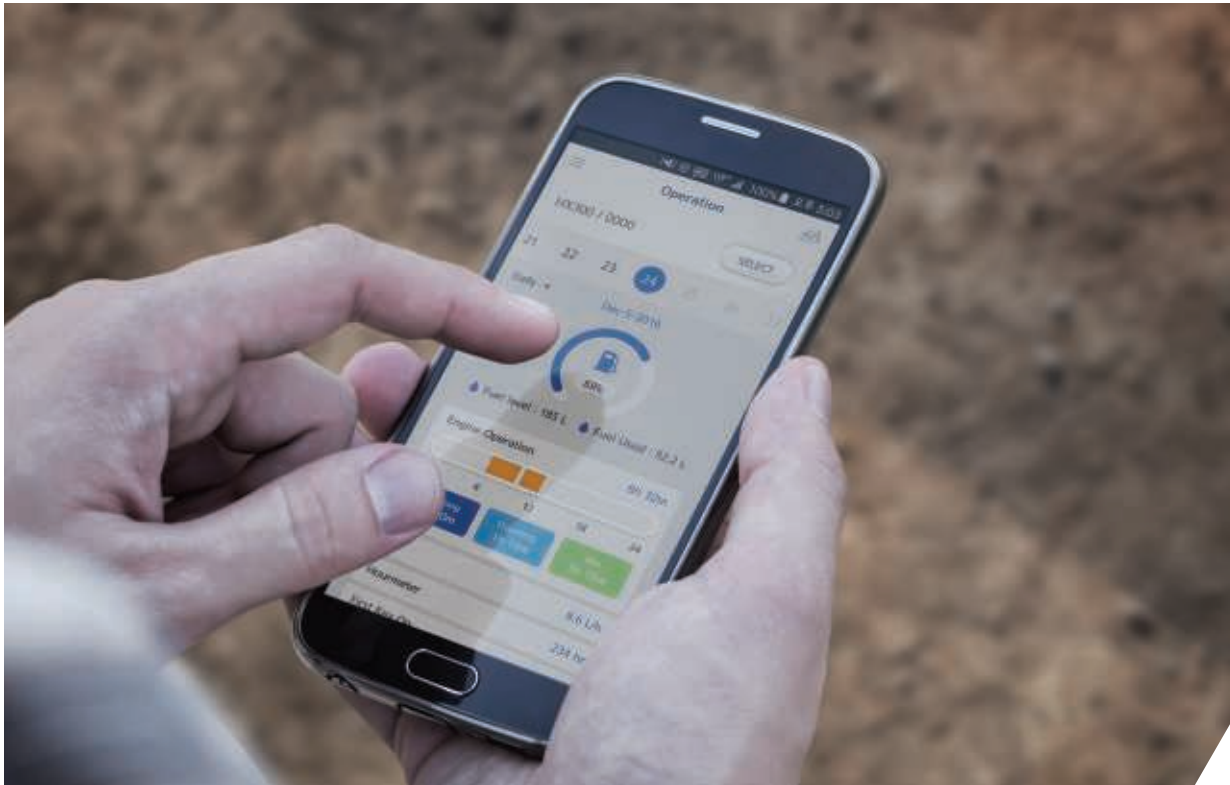

For maximum convenience and security, the HX220AL features Hyundai's exclusive Hi Mate remote fleet management system, which uses mobile data technology to provide the highest level of service and support. You can monitor your machines from any location via a dedicated website or mobile app, with access to working parameters like total engine hours, machine utilisation, actual performed working hours, fuel consumption and machine location. The system makes it easy to evaluate machine productivity, plan servicing and maintenance tasks, as well as any required cost saving measures. It also offers geofencing to protect your machines against theft and unauthorised usage.

ECD (Engine Connected Diagnostics) provides troubleshooting advice as well as tailored servicing and parts support from Cummins Quickserve. Service technicians are supported with remote diagnostics reports allowing them to prepare for site visits and bring the right tools.



READY FOR ACTION AND BUILT TO LAST

You need to know that the investment you make today will help to sustain your business over the long term. That's why we prioritised reliability throughout the development of the HX220AL, from design and manufacturing to quality control. We improved engine reliability by removing the EGR and integrating exhaust after treatment with a simplified, single-module system that's easier to maintain. The upper and lower frame structures are reinforced for high load work, while the attachments have been rigorously tested for the roughest conditions. The overall aim is to minimise downtime and repairs so that you can stay on schedule, avoid unexpected costs and protect your profits.

The engine and **exhaust after-treatment** system are integrated for simplified control and maintenance. ▶





- ◀ **High-grade hoses** with outstanding resistance to heat and pressure provide maximum durability, even in rough working conditions.



- ◀ The reinforced **pins, bushings and polymer shims** are designed for an extended lifetime.

FOCUSED TECHNOLOGIES FOR THE RESULTS YOU WANT

Hyundai's A-series crawler excavators are designed to create better conditions for operators and deliver the ultimate ownership experience. Every detail is carefully fine-tuned to match your needs in the field, including better safety and comfort, higher productivity, maximum uptime and easy servicing. It's all part of the Hyundai Effect.

See more at hyundai-ce.eu



SPECIFICATIONS

ENGINE	
Maker / Model	Cummins B6.7 / STAGE V
Type	Turbocharged, charge air cooled, diesel engine
Gross power (SAE J1995)	173 HP (129 kW) at 2,200 rpm
Net power (SAE J1349)	170 HP (127 kW) at 2,200 rpm
Max. Power	195 HP (145kW) at 2,000 rpm
Peak torque	881 N·m (650 lb ft) at 1,300 rpm
Displacement	6,700 cc (408 cu in)

HYDRAULIC SYSTEM	
MAIN PUMP	
Type	Variable displacement tandem axis piston pumps
Max. Flow	2 × 222 l/min
Sub-pump for pilot circuit	Gear pump
Cross-sensing and fuel saving pump system	
HYDRAULIC MOTORS	
Travel	Two speed axial pistons motor with brake valve and parking brake
Swing	Axial piston motor with automatic brake
RELIEF VALVE SETTING	
Implement circuits	350 kgf/cm ² (4,980 psi)
Travel	350 kgf/cm ² (4,980 psi)
Power Boost (boom, arm, bucket)	380 kgf/cm ² (5,400 psi)
Swing circuit	265 kgf/cm ² (3,770 psi)
Pilot circuit	40 kgf/cm ² (570 psi)
Service valve	Installed
HYDRAULIC CYLINDERS	
No. of cylinder bore X stroke	Boom: Ø 120 × 1,290 mm
	Arm: Ø 140 × 1,510 mm
	Bucket: Ø 120 × 1,055 mm

* Hyundai Bio Hydraulic Oil (HBHO) available.

DRIVING AND BRAKING	
Drive method	Fully hydrostatic type
Driving Motor	Axial piston motor, in-shoe design
Deceleration System	Planetary reduction gear
Max. Drawbar Pull	20,800 kgf (45,860 lbf)
Max. travel speed (high / low)	5.4 km/hr (3.4 mph) / 3.5 km/hr (2.2 mph)
Gradeability	35° (70%)
Parking brake	Multi wet disc

CONTROL	
Pilot pressure operated joysticks and pedals with detachable lever provide almost effortless and fatigueless operation.	
Pilot control	Two joysticks with one safety lever (LH): Swing and arm, Boom and bucket
Traveling and steering	Two levers with pedals
Engine throttle	Electric, Dial type

SWING SYSTEM	
Swing motor	Fixed displacement axial piston motor
Swing reduction	Planetary gear reduction
Swing bearing lubrication	Grease-bathed
Swing brake	Multi wet disc
Swing speed	11.4 rpm

CAPACITIES			
	liter	US gal	UK gal
Fuel tank	400	106	88
Engine coolant	40	10.6	8.8
Engine oil	23.1	6.1	5.1
Swing device	6.2	1.64	1.36
Final Drive (each)	4.5	1.2	1
Hydraulic system (including tank)	275	72.6	60.5
Hydraulic tank	155	40.9	34.1
DEF/AdBlue®	48	12.6	10.5

UNDERCARRIAGE	
The X-leg type center frame is integrally welded with reinforced box-section track frames. The undercarriage includes lubricated rollers, idlers, track adjusters with shock absorbing springs and sprockets, and a track chain with double or triple grouser shoes.	
Center frame	X - leg type
Track frame	Pentagonal box type
No. of shoes on each side	49 EA
No. of carrier roller on each side	2 EA
No. of track roller on each side	9 EA
No. of rail guard on each side	2 EA

OPERATING WEIGHT (APPROXIMATE)	
Operating weight, including 5,680 mm (18' 8") boom, 2,920 mm (9' 7") arm, SAE heaped 0.92 m ³ (1.20 yd ³) bucket, lubricant, coolant, full fuel tank, full hydraulic tank, and all standard equipments.	

OPERATING WEIGHT				
Shoes		Operating weight		Ground pressure
Type	Width mm (in)		kg (lb)	kgf/cm ² (psi)
Triple grouser	600 (24")	HX220AL	22,100 (48,720)	0.47 (6.71)
		HX220ALHW	23,560 (51,940)	0.50 (7.15)
	700 (28")	HX220AL	22,380 (49,340)	0.41 (5.82)
		HX220ALHW	23,840 (52,560)	0.44 (6.20)
	800 (32")	HX220AL	22,660 (49,960)	0.36 (5.16)
		HX220ALHW	24,120 (53,170)	0.39 (5.49)
900 (36")	HX220AL	22,940 (50,570)	0.33 (4.64)	
	HX220ALHW	24,400 (53,790)	0.35 (4.94)	
Double grouser	700 (28")	HX220ALHW	24,040 (53,000)	0.44 (6.25)

AIR CONDITIONING SYSTEM	
The air condition system for the machine contains the fluorinated greenhouse gas with global warming potential of R134a. (Global Warming Potential: 1.430) The system holds 0.75kg refrigerant consisting of a CO ₂ of 1.07 metric tonnes. For more information, please refer to the manual.	

DIMENSIONS & WORKING RANGE

HX220AL DIMENSIONS

5.68 m (18' 8") BOOM and 2.0 m (6' 7"); 2.4 m (7' 10"); 2.92 m (9' 7") & 3.9 m (12' 10") ARM

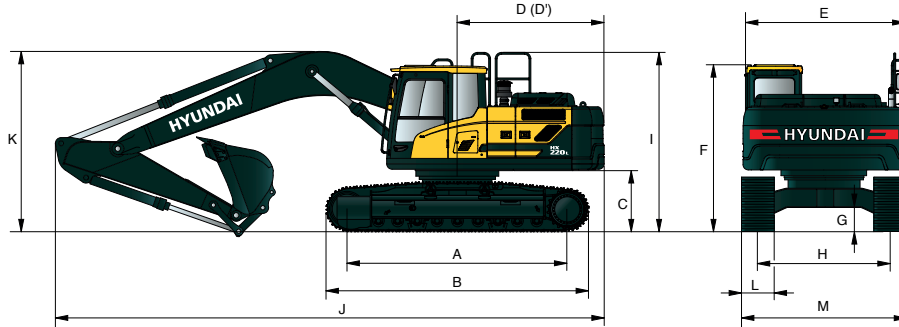

Unit : mm (ft.in)

A	Tumbler distance	3,650 (12' 0")
B	Overall length of crawler	4,404 (14' 4")
C	Ground clearance of counterweight	1,060 (3' 6")
D	Tail swing radius	2,890 (9' 5")
D'	Rear-end length	2,770 (9' 1")
E	Overall width of upperstructure	2,740 (9' 0")
F	Overall height of cabin	3,000 (9' 8")
G	Min. ground clearance	470 (1' 7")
H	Track gauge	2,390 (7' 10")
I	Overall height of guardrail	3,210 (10' 5")

	Boom length	5,680 (18' 8")			
	Arm length	2,000 (6' 7")	2,400 (7' 10")	2,920 (9' 7")	3,900 (12' 10")
J	Overall length	9,650 (31' 8")	9,570 (31' 5")	9,530 (31' 3")	9,520 (31' 3")
K	Overall height of boom	3,200 (10' 6")	3,110 (10' 2")	3,030 (9' 11")	3,480 (11' 5")
L	Track shoe width	600 (24")	700 (28")	800 (32")	900 (36")
M	Overall width	2,990 (9' 10")	3,090 (10' 2")	3,190 (10' 6")	3,290 (10' 10")

* This figure includes the size of grouser.

HX220AL WORKING RANGE

Unit : mm (ft.in)

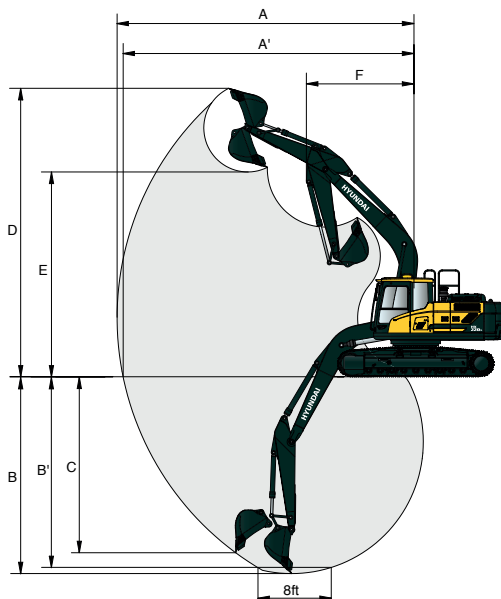

	Boom length	5,680 (18' 8")			
	Arm length	2,000 (6' 7")	2,400 (7' 10")	2,920 (9' 7")	3,900 (12' 10")
A	Max. digging reach	9,140 (30' 0")	9,500 (31' 2")	9,980 (32' 9")	10,910 (35' 10")
A'	Max. digging reach on ground	8,960 (29' 5")	9,330 (30' 7")	9,820 (32' 3")	10,770 (35' 4")
B	Max. digging depth	5,820 (19' 1")	6,220 (20' 5")	6,730 (22' 1")	7,720 (25' 4")
B'	Max. digging depth (8' level)	5,580 (18' 4")	6,010 (19' 9")	6,560 (21' 6")	7,580 (24' 10")
C	Max. vertical wall digging depth	5,280 (17' 4")	5,720 (18' 9")	6,280 (20' 7")	7,240 (23' 9")
D	Max. digging height	9,140 (30' 0")	9,340 (30' 8")	9,600 (31' 6")	10,110 (33' 2")
E	Max. dumping height	6,330 (20' 9")	6,520 (21' 5")	6,780 (22' 3")	7,290 (23' 11")
F	Min. front swing radius	3,750 (12' 4")	3,740 (12' 3")	3,670 (12' 0")	3,700 (12' 2")

DIMENSIONS & WORKING RANGE

HX220AL 2-PIECE BOOM DIMENSIONS

5.65 m (18' 6") 2-Piece BOOM and 2.0 m (6' 7"); 2.4 m (7' 10") & 2.92 m (9' 7") ARM

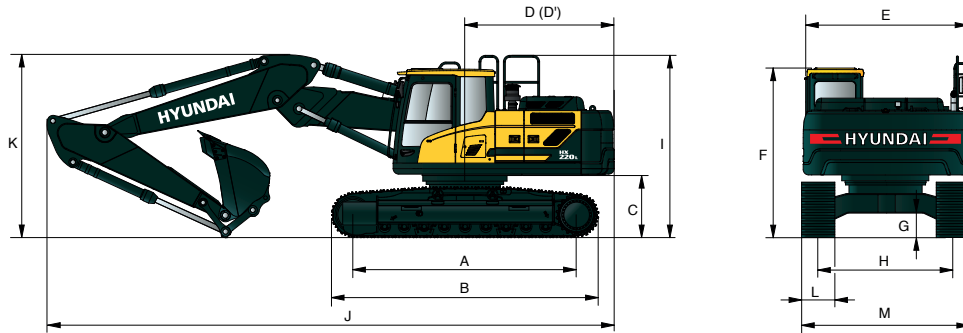

Unit : mm (ft-in)

A	Tumbler distance	3,650 (12' 0")
B	Overall length of crawler	4,404 (14' 4")
C	Ground clearance of counterweight	1,060 (3' 6")
D	Tail swing radius	2,890 (9' 5")
D'	Rear-end length	2,770 (9' 1")
E	Overall width of upperstructure	2,740 (9' 0")
F	Overall height of cabin	3,000 (9' 8")
G	Min. ground clearance	470 (1' 7")
H	Track gauge	2,390 (7' 10")
I	Overall height of guardrail	3,210 (10' 5")

	Boom length	5,650 (18' 6") 2-Piece Boom			
	Arm length	2,000 (6' 7")	2,400 (7' 10")	2,920 (9' 7")	
J	Overall length	9,650 (31' 8")	9,570 (31' 5")	9,530 (31' 3")	
K	Overall height of boom	3,200 (10' 6")	3,110 (10' 2")	3,030 (9' 11")	
L	Track shoe width	600 (24")	700 (28")	800 (32")	900 (36")
M	Overall width	2,990 (9' 10")	3,090 (10' 2")	3,190 (10' 6")	3,290 (10' 10")

* This figure includes the size of grouser.

HX220AL 2-PIECE BOOM WORKING RANGE

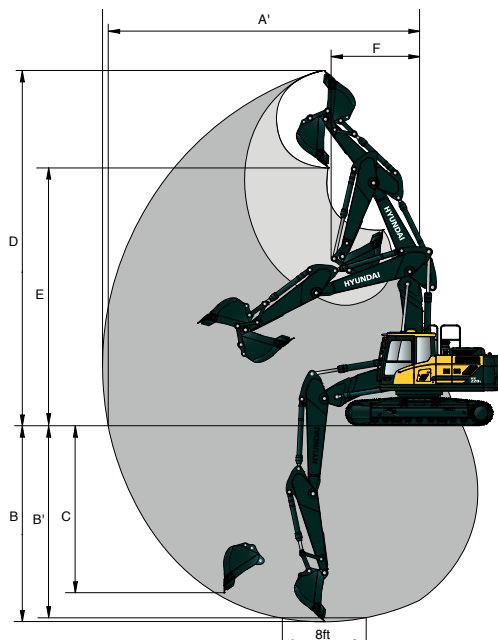

Unit : mm (ft-in)

	Boom length	5,650 (18' 6") 2-Piece Boom		
	Arm length	2,000 (6' 7")	2,400 (7' 10")	2,920 (9' 7")
A	Max. digging reach	9,120 (29' 11")	9,530 (31' 3")	10,020 (32' 10")
A'	Max. digging reach on ground	8,950 (29' 4")	9,360 (30' 8")	9,860 (32' 4")
B	Max. digging depth	5,480 (18' 0")	5,880 (19' 3")	6,400 (21' 0")
B'	Max. digging depth (8' level)	5,360 (17' 7")	5,770 (18' 11")	6,290 (20' 8")
C	Max. vertical wall digging depth	4,540 (14' 11")	5,020 (16' 6")	5,560 (18' 3")
D	Max. digging height	10,310 (33' 10")	10,670 (35' 0")	11,090 (36' 5")
E	Max. dumping height	7,390 (24' 3")	7,750 (25' 5")	8,160 (26' 9")
F	Min. front swing radius	2,870 (9' 5")	2,660 (8' 9")	2,530 (8' 4")

DIMENSIONS & WORKING RANGE

HX220AL LONG REACH DIMENSIONS

8.2 m (26' 11") BOOM and 6.3 m (20' 8") ARM

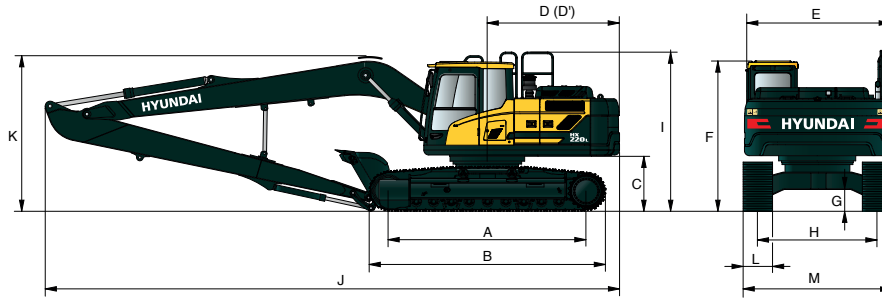

Unit : mm (ft.in)

A	Tumbler distance	3,650 (12' 0")
B	Overall length of crawler	4,404 (14' 4")
C	Ground clearance of counterweight	1,060 (3' 6")
D	Tail swing radius	2,890 (9' 5")
D'	Rear-end length	2,770 (9' 1")
E	Overall width of upperstructure	2,740 (9' 0")
F	Overall height of cabin	3,000 (9' 8")
G	Min. ground clearance	470 (1' 7")
H	Track gauge	2,390 (7' 10")
I	Overall height of guardrail	3,210 (10' 5")

	Boom length	8,200 (26' 11")
	Arm length	6,300 (20' 8")
J	Overall length	12,030 (39' 6")
K	Overall height of boom	3,280 (10' 9")
L	Track shoe width	800 (32")
M	Overall width	3,190 (10' 6")

HX220AL LONG REACH WORKING RANGE

Unit : mm (ft.in)

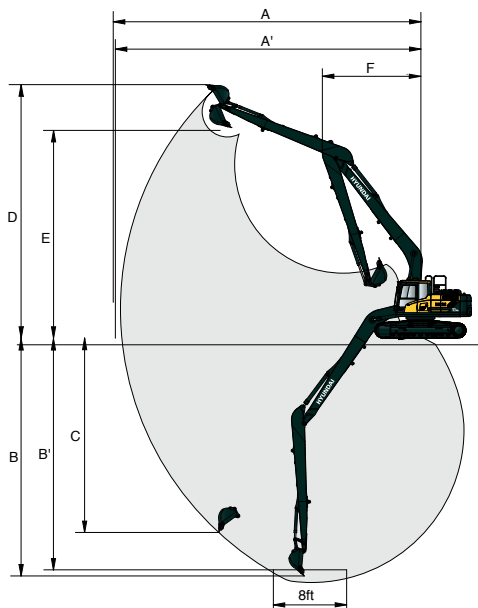

	Boom length	8,200 (26' 11")
	Arm length	6,300 (20' 8")
A	Max. digging reach	15,220 (50' 0")
A'	Max. digging reach on ground	15,120 (49' 7")
B	Max. digging depth	11,760 (38' 7")
B'	Max. digging depth (8' level)	11,650 (38' 3")
C	Max. vertical wall digging depth	9,610 (31' 6")
D	Max. digging height	12,550 (41' 2")
E	Max. dumping height	10,280 (33' 8")
F	Min. front swing radius	4,870 (16' 0")

DIMENSIONS & WORKING RANGE

HX220AL HIGH WALKER DIMENSIONS

5.68 m (18' 8") BOOM and 2.0 m (6' 7"); 2.4 m (7' 10") & 2.92 m (9' 7") ARM

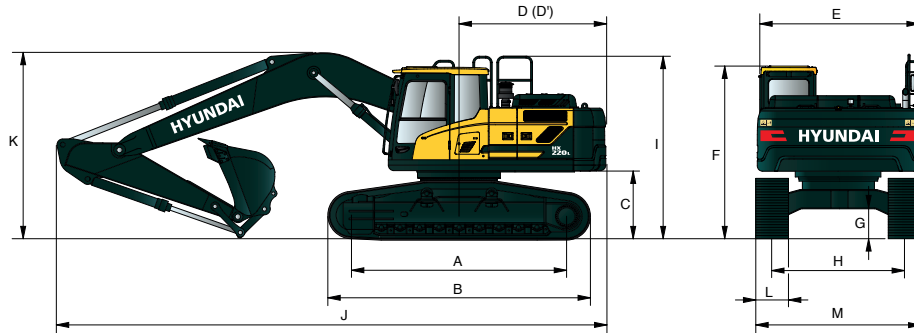

Unit : mm (ft-in)

A	Tumbler distance	3,650 (12' 0")
B	Overall length of crawler	4,404 (14' 4")
C	Ground clearance of counterweight	1,260 (4' 1")
D	Tail swing radius	2,890 (9' 5")
D'	Rear-end length	2,770 (9' 1")
E	Overall width of upperstructure	2,740 (9' 0")
F	Overall height of cabin	3,200 (10' 5")
G	Min. ground clearance	660 (2' 2")
H	Track gauge	2,795 (9' 2")
I	Overall height of guardrail	3,410 (11' 2")

	Boom length	5,680 (18' 8")					
	Arm length	2,000 (6' 7")	2,400 (7' 10")	2,920 (9' 7")	3,900 (12' 10")		
J	Overall length	9,650 (31' 8")	9,550 (31' 4")	9,470 (31' 1")	9,560 (31' 4")		
K	Overall height of boom	3,290 (10' 10")	3,170 (10' 5")	3,060 (10' 0")	3,450 (11' 4")		
L	Track shoe width	Type	Triple grouser				Double grouser
		Width	600 (24")	700 (28")	800 (32")	900 (36")	700 (28")
M	Overall width	3,395 (11' 2")	3,495 (11' 6")	3,595 (11' 10")	3,695 (12' 2")	3,495 (11' 6")	

HX220AL HIGH WALKER WORKING RANGE

Unit : mm (ft-in)

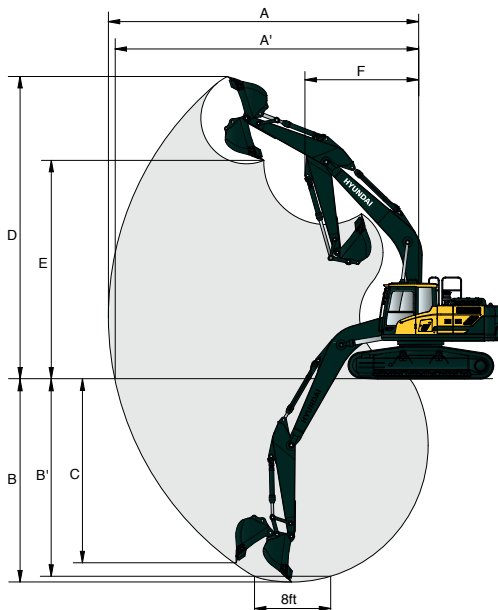

	Boom length	5,680 (18' 8")			
	Arm length	2,000 (6' 7")	2,400 (7' 10")	2,920 (9' 7")	3,900 (12' 10")
A	Max. digging reach	9,140 (30' 0")	9,500 (31' 2")	9,980 (32' 9")	10,910 (35' 10")
A'	Max. digging reach on ground	8,920 (29' 3")	9,290 (30' 6")	9,820 (32' 3")	10,730 (35' 2")
B	Max. digging depth	5,630 (18' 6")	6,010 (19' 9")	6,550 (21' 6")	7,530 (24' 8")
B'	Max. digging depth (8' level)	5,390 (17' 8")	5,820 (19' 1")	6,380 (20' 11")	7,390 (24' 3")
C	Max. vertical wall digging depth	5,090 (16' 8")	5,630 (18' 6")	6,100 (20' 0")	7,050 (23' 1")
D	Max. digging height	9,330 (30' 7")	9,530 (31' 3")	9,780 (32' 1")	10,300 (33' 9")
E	Max. dumping height	6,520 (21' 5")	6,710 (22' 0")	6,960 (22' 10")	7,480 (24' 6")
F	Min. front swing radius	3,750 (12' 4")	3,740 (12' 3")	3,670 (12' 0")	3,700 (12' 2")

BUCKET SELECTION GUIDE & DIGGING FORCE

BUCKETS

All buckets are welded with high-strength steel.



SAE heaped m ³ (yd ³)	0.80 (1.05)	1.34 (1.75)	◆ 0.90 (1.18)	◆ 0.87 (1.14)	◆ 1.20 (1.57)	★ 0.52 (0.68)
	0.92 (1.20)		◆ 1.05 (1.37)			
	1.10 (1.44)					
	1.20 (1.57)					

Capacity m ³ (yd ³)		Width mm (in)	Weight kg (lb)	Tooth (EA)	Recommendation mm (ft.in)							
SAE heaped	CECE heaped	Without side cutters			5,680 (18' 8") Boom				8,200 (26' 11") Boom	5,650 (18' 6") Boom		
					2,000 (6' 7") Arm	2,400 (7' 10") Arm	2,920 (9' 7") Arm	3,900 (12' 10") Arm	6,300 (20' 8") Arm	2,000 (6' 7") Arm	2,400 (7' 10") Arm	2,920 (9' 7") Arm
0.80 (1.05)	0.70 (0.92)	1,070 (42.1)	770 (1,700)	5	●	●	●	○	-	●	●	●
0.92 (1.20)	0.80 (1.05)	1,190 (46.9)	820 (1,810)	5	●	●	●	■	-	●	●	●
1.10 (1.44)	0.96 (1.26)	1,375 (54.1)	890 (1,960)	5	●	●	○	▲	-	●	○	■
1.20 (1.57)	1.05 (1.37)	1,390 (54.7)	920 (2,030)	5	●	○	■	▲	-	○	○	■
1.34 (1.75)	1.17 (1.53)	1,525 (60.0)	990 (2,180)	6	○	■	▲	x	-	○	■	▲
◆ 0.90 (1.18)	0.79 (1.03)	1,210 (47.6)	880 (1,940)	5	●	●	●	■	-	●	●	●
◆ 1.05 (1.37)	0.92 (1.20)	1,355 (53.3)	940 (2,070)	5	●	●	○	▲	-	●	●	○
◆ 0.87 (1.14)	0.77 (1.01)	1,195 (47.0)	940 (2,070)	5	●	●	●	-	-	●	●	●
◆ 1.20 (1.57)	1.05 (1.37)	1,520 (59.8)	1,120 (2,470)	6	○	○	■	-	-	○	■	■
★ 0.52 (0.68)	0.45 (0.59)	945 (37.2)	460 (1,010)	5	-	-	-	-	○	-	-	-

- ◆ Heavy duty bucket
- ◆ Rock-Heavy duty bucket
- ★ Long reach bucket

- Applicable for materials with density of 2100kg/m³ (3500 lb/yd³) or less
- Applicable for materials with density of 1800kg/m³ (3000 lb/yd³) or less
- Applicable for materials with density of 1500kg/m³ (2500 lb/yd³) or less
- ▲ Applicable for materials with density of 1200kg/m³ (2000 lb/yd³) or less
- x Not recommended

ATTACHMENT

Booms and arms are welded with a low-stress, full-box section design.
5.68 m, 8.2 m Booms and 2.0 m, 2.4 m, 2.92 m, 3.9 m & 6.3 m Arms are available.

DIGGING FORCE

Boom	Length	5,680 (18' 8")				5,650 (18' 6") 2-Piece			8,200 (26' 11")	Remark
	Weight	1,950 (4,300)				2,600 (5,730)			2,350 (5,180)	
Arm	Length	2,000 (6' 7")	2,400 (7' 10")	2,920 (9' 7")	3,900 (12' 10")	2,000 (6' 7")	2,400 (7' 10")	2,920 (9' 7")	6,300 (20' 8")	
	Weight	975 (2,150)	1,045 (2,300)	1,095 (2,410)	1,295 (2,850)	975 (2,150)	1,045 (2,300)	1,095 (2,410)	1,330 (2,930)	
Bucket digging force	SAE	kN	133.4 [144.8]				133.4 [144.8]			72.6
		kgf	13,600 [14,770]				13,600 [14,770]			7,400
		lbf	29,980 [32,550]				29,980 [32,550]			16,310
	ISO	kN	152.0 [165.0]				152.0 [165.0]			83.4
		kgf	15,500 [16,830]				15,500 [16,830]			8,500
		lbf	34,170 [37,100]				34,170 [37,100]			18,740
Arm crowd force	SAE	kN	144.2 [156.5]	119.6 [129.9]	102.0 [110.7]	84.3 [91.6]	144.2 [156.5]	119.6 [129.9]	102.0 [110.7]	49.0
		kgf	14,700 [15,960]	12,200 [13,250]	10,400 [11,290]	8,600 [9,340]	14,700 [15,960]	12,200 [13,250]	10,400 [11,290]	5,000
		lbf	32,410 [35,190]	26,900 [29,210]	22,930 [24,900]	18,960 [20,590]	32,410 [35,190]	26,900 [29,210]	22,930 [24,900]	11,020
	ISO	kN	151.0 [164.0]	125.5 [136.3]	106.9 [116.1]	87.3 [94.8]	151.0 [164.0]	125.5 [136.3]	106.9 [116.1]	50.0
		kgf	15,400 [16,720]	12,800 [13,900]	10,900 [11,830]	8,900 [9,660]	15,400 [16,720]	12,800 [13,900]	10,900 [11,830]	5,100
		lbf	33,950 [36,860]	28,220 [30,640]	24,030 [26,090]	19,620 [21,300]	33,950 [36,860]	28,220 [30,640]	24,030 [26,090]	11,240











Note: Boom weight includes arm cylinder, piping, and pin
Arm weight includes bucket cylinder, linkage, and pin

LIFTING CAPACITY











 Rating over-front
  Rating over-side or 360 degrees

HX220AL

5.68 m (18' 8") Mono boom, 2.00 m (6' 7") arm equipped with 600 mm (24") triple grouser shoe.

Load point height m (ft)		Load radius								At max. Reach		
		3.0 m (9.8 ft)		4.5 m (14.8 ft)		6.0 m (19.7 ft)		7.5 m (24.6 ft)		Capacity		Reach m (ft)
												
7.5 m (24.6 ft)	kg lb									*5,720 *12,610	*5,720 *12,610	5.00 (16.4)
6.0 m (19.7 ft)	kg lb					*5,460 *12,040	5,440 11,990			*5,530 *12,190	4,940 10,890	6.35 (20.8)
4.5 m (14.8 ft)	kg lb			*6,900 *15,210	*6,900 *15,210	*5,810 *12,810	5,310 11,710			*5,570 *12,280	4,040 8,910	7.14 (23.4)
3.0 m (9.8 ft)	kg lb			*8,690 *19,160	7,640 16,840	*6,540 *14,420	5,090 11,220	5,640 12,430	3,670 8,090	5,580 12,300	3,630 8,000	7.55 (24.8)
1.5 m (4.9 ft)	kg lb					*7,270 *16,030	4,880 10,760	5,550 12,240	3,590 7,910	5,400 11,900	3,500 7,720	7.64 (25.1)
Ground Line	kg lb			*10,520 *23,190	7,090 15,630	7,580 16,710	4,760 10,490			5,580 12,300	3,590 7,910	7.43 (24.4)
-1.5 m (-4.9 ft)	kg lb			*10,220 *22,530	7,100 15,650	7,560 16,670	4,750 10,470			6,230 13,730	3,980 8,770	6.88 (22.6)
-3.0 m (-9.8 ft)	kg lb	*12,370 *27,270	*12,370 *27,270	*9,130 *20,130	7,240 15,960					*6,670 *14,700	4,980 10,980	5.90 (19.4)
-4.5 m (-14.8 ft)	kg lb											

5.68 m (18' 8") Mono boom, 2.40 m (7' 10") arm equipped with 600 mm (24") triple grouser shoe.

Load point height m (ft)		Load radius								At max. Reach		
		3.0 m (9.8 ft)		4.5 m (14.8 ft)		6.0 m (19.7 ft)		7.5 m (24.6 ft)		Capacity		Reach m (ft)
												
7.5 m (24.6 ft)	kg lb									*5,080 *11,200	*5,080 *11,200	5.58 (18.3)
6.0 m (19.7 ft)	kg lb					*5,010 *11,050	*5,010 *11,050			*4,610 *10,160	4,430 9,770	6.82 (22.4)
4.5 m (14.8 ft)	kg lb			*6,350 *14,000	*6,350 *14,000	*5,450 *12,020	5,340 11,770	*5,000 *11,020	3,750 8,270	*4,490 *9,900	3,700 8,160	7.55 (24.8)
3.0 m (9.8 ft)	kg lb			*8,150 *17,970	7,740 17,060	*6,230 *13,730	5,110 11,270	*5,420 *11,950	3,670 8,090	*4,580 *10,100	3,360 7,410	7.94 (26.1)
1.5 m (4.9 ft)	kg lb			*9,710 *21,410	7,270 16,030	*7,030 *15,500	4,880 10,760	5,530 12,190	3,570 7,870	*4,860 *10,710	3,230 7,120	8.03 (26.3)
Ground Line	kg lb			*10,410 *22,950	7,060 15,560	7,550 16,640	4,730 10,430	5,460 12,040	3,500 7,720	5,140 11,330	3,310 7,300	7.83 (25.7)
-1.5 m (-4.9 ft)	kg lb	*10,830 *23,880	*10,830 *23,880	*10,330 *22,770	7,040 15,520	7,500 16,530	4,690 10,340			5,660 12,480	3,620 7,980	7.31 (24.0)
-3.0 m (-9.8 ft)	kg lb	*13,260 *29,230	*13,260 *29,230	*9,490 *20,920	7,140 15,740	*6,960 *15,340	4,770 10,520			*6,300 *13,890	4,390 9,680	6.40 (21.0)
-4.5 m (-14.8 ft)	kg lb			*7,150 *15,760	*7,150 *15,760					*6,320 *13,930	*6,320 *13,930	4.89 (16.0)

1. Lifting capacity is based on ISO 10567.

2. Lifting capacity of the HX A Series does not exceed 75% of tipping load with the machine on firm, level ground or 87% of full hydraulic capacity.

3. The Lift-point is bucket pivot mounting pin on the arm (without bucket mass).













4. (*) indicates load limited by hydraulic capacity.

LIFTING CAPACITY















 Rating over-front  Rating over-side or 360 degrees

HX220AL

5.68 m (18' 8") Mono boom, 2.92 m (9' 7") arm equipped with 800 mm triple grouser shoe.

Load point height m (ft)	Load radius										At max. Reach			
	1.5 m (4.9 ft)		3.0 m (9.8 ft)		4.5 m (14.8 ft)		6.0 m (19.7 ft)		7.5 m (24.6 ft)		Capacity		Reach m (ft)	
														
7.5 m (24.6 ft)	kg							*4,460	*4,460			*3,370	*3,370	6.26
	lb							*9,830	*9,830			*7,430	*7,430	(20.5)
6.0 m (19.7 ft)	kg							*4,460	*4,460			*3,100	*3,100	7.38
	lb							*9,830	*9,830			*6,830	*6,830	(24.2)
4.5 m (14.8 ft)	kg							*4,970	*4,970	*4,710	3,900	*3,020	*3,020	8.07
	lb							*10,960	*10,960	*10,380	8,600	*6,660	*6,660	(26.5)
3.0 m (9.8 ft)	kg				*7,410	*7,410	*5,800	5,300	*5,070	3,790	*3,070	*3,070	*3,070	8.43
	lb				*16,340	*16,340	*12,790	11,680	*11,180	8,360	*6,770	*6,770	*6,770	(27.7)
1.5 m (4.9 ft)	kg				*9,140	7,570	*6,680	5,040	*5,520	3,670	*3,250	3,040	3,040	8.51
	lb				*20,150	16,690	*14,730	11,110	*12,170	8,090	*7,170	6,700	6,700	(27.9)
Ground Line	kg			*5,930	*5,930	*10,140	7,270	*7,330	4,860	5,600	3,570	*3,590	3,090	8.32
	lb			*13,070	*13,070	*22,350	16,030	*16,160	10,710	12,350	7,870	*7,910	6,810	(27.3)
-1.5 m (-4.9 ft)	kg	*6,500	*6,500	*10,400	*10,400	*10,350	7,180	*7,590	4,780	5,560	3,540	*4,200	3,350	7.84
	lb	*14,330	*14,330	*22,930	*22,930	*22,820	15,830	*16,730	10,540	12,260	7,800	*9,260	7,390	(25.7)
-3.0 m (-9.8 ft)	kg	*11,120	*11,120	*14,180	14,090	*9,820	7,240	*7,250	4,810			*5,420	3,940	7.00
	lb	*24,520	*24,520	*31,260	31,060	*21,650	15,960	*15,980	10,600			*11,950	8,690	(23.0)
-4.5 m (-14.8 ft)	kg			*11,610	*11,610	*8,190	7,450					*6,080	5,420	5.65
	lb			*25,600	*25,600	*18,060	16,420					*13,400	11,950	(18.5)

5.68 m (18' 8") Mono boom, 3.90 m (12' 9") arm equipped with 600 mm (24") triple grouser shoe.

Load point height m (ft)	Load radius										At max. Reach					
	1.5 m (4.9 ft)		3.0 m (9.8 ft)		4.5 m (14.8 ft)		6.0 m (19.7 ft)		7.5 m (24.6 ft)		9.0 m (29.5 ft)		Capacity		Reach m (ft)	
																
7.5 m (24.6 ft)	kg													*2,330	*2,330	7.49
	lb													*5,140	*5,140	(24.6)
6.0 m (19.7 ft)	kg									*3,680	*3,680			*2,170	*2,170	8.44
	lb									*8,110	*8,110			*4,780	*4,780	(27.7)
4.5 m (14.8 ft)	kg									*3,920	3,820	*2,330	*2,330	*2,120	*2,120	9.05
	lb									*8,640	8,420	*5,140	*5,140	*4,670	*4,670	(29.7)
3.0 m (9.8 ft)	kg				*5,890	*5,890	*4,880	*4,880	*4,370	3,680	*3,530	2,710	*2,150	*2,150	9.37	
	lb				*12,990	*12,990	*10,760	*10,760	*9,630	8,110	*7,780	5,970	*4,740	*4,740	(30.7)	
1.5 m (4.9 ft)	kg			*8,630	*8,630	*7,850	7,470	*5,870	4,900	*4,920	3,510	*4,080	2,630	*2,250	*2,250	9.45
	lb			*19,030	*19,030	*17,310	16,470	*12,940	10,800	*10,850	7,740	*8,990	5,800	*4,960	*4,960	(31.0)
Ground Line	kg			*7,210	*7,210	*9,310	7,000	*6,730	4,640	5,330	3,370	*3,890	2,570	*2,440	*2,440	9.28
	lb			*15,900	*15,900	*20,530	15,430	*14,840	10,230	11,750	7,430	*8,580	5,670	*5,380	*5,380	(30.4)
-1.5 m (-4.9 ft)	kg	*5,430	*5,430	*9,370	*9,370	*10,030	6,770	*7,260	4,480	5,240	3,280			*2,780	2,610	8.85
	lb	*11,970	*11,970	*20,660	*20,660	*22,110	14,930	*16,010	9,880	11,550	7,230			*6,130	5,750	(29.0)
-3.0 m (-9.8 ft)	kg	*8,510	*8,510	*13,040	*13,040	*10,030	6,730	7,250	4,440	5,220	3,270			*3,380	2,950	8.12
	lb	*18,760	*18,760	*28,750	*28,750	*22,110	14,840	15,980	9,790	11,510	7,210			*7,450	6,500	(26.6)
-4.5 m (-14.8 ft)	kg	*12,380	*12,380	*13,530	13,400	*9,220	6,840	*6,720	4,520					*4,660	3,700	6.99
	lb	*27,290	*27,290	*29,830	29,540	*20,330	15,080	*14,820	9,960					*10,270	8,160	(22.9)
-6.0 m (-19.7 ft)	kg			*10,120	*10,120	*6,860	*6,860							*5,510	*5,510	5.21
	lb			*22,310	*22,310	*15,120	*15,120							*12,150	*12,150	(17.1)

- Lifting capacity is based on ISO 10567.
- Lifting capacity of the HX A Series does not exceed 75% of tipping load with the machine on firm, level ground or 87% of full hydraulic capacity.
- The Lift-point is bucket pivot mounting pin on the arm (without bucket mass).
- (*) indicates load limited by hydraulic capacity.

LIFTING CAPACITY



Rating over-front



Rating over-side or 360 degrees

HX220AL

5.68 m (18' 8") Mono boom, 2.92 m (9' 7") arm equipped with 600 mm (24") triple grouser shoe.

Load point height m (ft)	Load radius										At max. Reach			
	1.5 m (4.9 ft)		3.0 m (9.8 ft)		4.5 m (14.8 ft)		6.0 m (19.7 ft)		7.5 m (24.6 ft)		Capacity		Reach	
													m (ft)	
7.5 m (24.6 ft)	kg							*4,460	*4,460			*3,370	*3,370	6.26
	lb							*9,830	*9,830			*7,430	*7,430	(20.5)
6.0 m (19.7 ft)	kg							*4,460	*4,460			*3,100	*3,100	7.38
	lb							*9,830	*9,830			*6,830	*6,830	(24.2)
4.5 m (14.8 ft)	kg							*4,970	*4,970	*4,710	3,780	*3,020	*3,020	8.07
	lb							*10,960	*10,960	*10,380	8,330	*6,660	*6,660	(26.5)
3.0 m (9.8 ft)	kg					*7,410	*7,410	*5,800	5,140	*5,070	3,670	*3,070	3,050	8.43
	lb					*16,340	*16,340	*12,790	11,330	*11,180	8,090	*6,770	6,720	(27.7)
1.5 m (4.9 ft)	kg					*9,140	7,340	*6,680	4,890	*5,520	3,550	*3,250	2,940	8.51
	lb					*20,150	16,180	*14,730	10,780	*12,170	7,830	*7,170	6,480	(27.9)
Ground Line	kg			*5,930	*5,930	*10,140	7,040	*7,330	4,700	5,410	3,450	*3,590	2,990	8.32
	lb			*13,070	*13,070	*22,350	15,520	*16,160	10,360	11,930	7,610	*7,910	6,590	(27.3)
-1.5 m (-4.9 ft)	kg	*6,500	*6,500	*10,400	*10,400	*10,350	6,950	7,440	4,620	5,380	3,420	*4,200	3,230	7.84
	lb	*14,330	*14,330	*22,930	*22,930	*22,820	15,320	16,400	10,190	11,860	7,540	*9,260	7,120	(25.7)
-3.0 m (-9.8 ft)	kg	*11,120	*11,120	*14,180	13,660	*9,820	7,010	*7,250	4,650			*5,420	3,800	7.00
	lb	*24,520	*24,520	*31,260	30,120	*21,650	15,450	*15,980	10,250			*11,950	8,380	(23.0)
-4.5 m (-14.8 ft)	kg			*11,610	*11,610	*8,190	7,220					*6,080	5,250	5.65
	lb			*25,600	*25,600	*18,060	15,920					*13,400	11,570	(18.5)

8.20 m (26' 11") boom, 6.30 m (20' 8") arm equipped with 800 mm triple grouser shoe.

Load point height m (ft)	Load radius																At max. Reach						
	1.5 m (4.9 ft)		3.0 m (9.8 ft)		4.5 m (14.8 ft)		6.0 m (19.7 ft)		7.5 m (24.6 ft)		9.0 m (29.5 ft)		10.5 m (34.4 ft)		12.0 m (39.4 ft)		13.5 m (44.3 ft)		Capacity		Reach		
																					m (ft)		
10.5 m (34.4 ft)	kg																			*870	*870	10.88	
	lb																				*1,920	*1,920	(35.7)
9.0 m (29.5 ft)	kg																				*820	*820	11.94
	lb																				*1,810	*1,810	(39.2)
7.5 m (24.6 ft)	kg												*1,870	*1,870	*1,410	*1,410					*790	*790	12.74
	lb												*4,120	*4,120	*3,110	*3,110					*1,740	*1,740	(41.8)
6.0 m (19.7 ft)	kg												*1,990	*1,990	*1,780	*1,780					*790	*790	13.31
	lb												*4,390	*4,390	*3,920	*3,920					*1,740	*1,740	(43.7)
4.5 m (14.8 ft)	kg												*2,290	*2,290	*2,170	*2,170	*2,080	*2,080			*1,050	*1,050	13.70
	lb												*5,050	*5,050	*4,780	*4,780	*4,590	*4,590			*2,310	*2,310	(45.0)
3.0 m (9.8 ft)	kg												*2,980	*2,980	*2,630	*2,630	*2,400	*2,400	*2,250	2,000	*1,340	*1,340	13.92
	lb												*6,570	*6,570	*5,800	*5,800	*5,290	*5,290	*4,960	4,410	*2,950	*2,950	(45.7)
1.5 m (4.9 ft)	kg			*2,800	*2,800	*6,330	*6,330	*4,470	*4,470	*3,530	*3,530	*2,990	*2,990	*2,640	2,400	*2,410	1,910	*1,490	*1,490	*880	*880	13.97	
	lb			*6,170	*6,170	*13,960	*13,960	*9,850	*9,850	*7,780	*7,780	*6,590	*6,590	*5,820	5,290	*5,310	4,210	*3,280	*3,280	*1,940	*1,940	(45.8)	
Ground Line	kg			*2,410	*2,410	*6,270	*6,270	*5,260	5,020	*4,050	3,710	*3,340	2,870	*2,880	2,270	*2,580	1,830	*1,470	*1,470	*950	*950	13.85	
	lb			*5,310	*5,310	*13,820	*13,820	*11,600	11,070	*8,930	8,180	*7,360	6,330	*6,350	5,000	*5,690	4,030	*3,240	*3,240	*2,090	*2,090	(45.4)	
-1.5 m (-4.9 ft)	kg	*1,990	*1,990	*2,980	*2,980	*5,610	*5,610	*5,830	4,690	*4,460	3,480	*3,630	2,710	*3,090	2,160	*2,720	1,760	*1,170	*1,170	*1,040	*1,040	13.57	
	lb	*4,390	*4,390	*6,570	*6,570	*12,370	*12,370	*12,850	10,340	*9,830	7,670	*8,000	5,970	*6,810	4,760	*6,000	3,880	*2,580	*2,580	*2,290	*2,290	(44.5)	
-3.0 m (-9.8 ft)	kg	*2,870	*2,870	*3,800	*3,800	*6,050	*6,050	*6,170	4,510	*4,750	3,330	*3,850	2,600	*3,250	2,090	*2,810	1,710			*1,180	*1,180	13.11	
	lb	*6,330	*6,330	*8,380	*8,380	*13,340	*13,340	*13,600	9,940	*10,470	7,340	*8,490	5,730	*7,170	4,610	*6,190	3,770			*2,600	*2,600	(43.0)	
-4.5 m (-14.8 ft)	kg	*3,790	*3,790	*4,800	*4,800	*7,020	6,750	*6,290	4,450	*4,880	3,270	*3,960	2,540	*3,320	2,050	*2,380	1,700			*1,390	*1,390	12.45	
	lb	*8,360	*8,360	*10,580	*10,580	*15,480	14,880	*13,870	9,810	*10,760	7,210	*8,730	5,600	*7,320	4,520	*5,250	3,750			*3,060	*3,060	(40.9)	
-6.0 m (-19.7 ft)	kg	*4,800	*4,800	*5,970	*5,970	*8,340	6,840	*6,190	4,470	*4,850	3,270	*3,930	2,550	*3,250	2,070					*1,720	*1,720	11.56	
	lb	*10,580	*10,580	*13,160	*13,160	*18,390	15,080	*13,650	9,850	*10,690	7,210	*8,660	5,620	*7,170	4,560					*3,790	*3,790	(37.9)	
-7.5 m (-24.6 ft)	kg	*5,950	*5,950	*7,410	*7,410	*7,740	7,040	*5,830	4,590	*4,600	3,350	*3,700	2,620							*2,300	2,190	10.37	
	lb	*13,120	*13,120	*16,340	*16,340	*17,060	15,520	*12,850	10,120	*10,140	7,390	*8,160	5,780							*5,070	4,830	(34.0)	
-9.0 m (-29.5 ft)	kg			*9,290	*9,290	*6,700	*6,700	*5,100	4,790	*3,980	3,520									*3,160	2,880	8.77	
	lb			*20,480	*20,480	*14,770	*14,770	*11,240	10,560	*8,770	7,760									*6,970	6,350	(28.8)	
-10.5 m (-34.4 ft)	kg																						
	lb																						

1. Lifting capacity is based on ISO 10567.

2. Lifting capacity of the HX A Series does not exceed 75% of tipping load with the machine on firm, level ground or 87% of full hydraulic capacity.

3. The Lift-point is bucket pivot mounting pin on the arm (without bucket mass).











4. (*) indicates load limited by hydraulic capacity.

LIFTING CAPACITY

 Rating over-front  Rating over-side or 360 degrees

HX220AL 2-PIECE BOOM

3.673 m boom 2-Piece, 2.92 m (6' 7") arm equipped with 600 mm (24") triple grouser shoe.

Load point height m (ft)	Load radius								At max. Reach			
	3.0 m (9.8 ft)		4.5 m (14.8 ft)		6.0 m (19.7 ft)		7.5 m (24.6 ft)		Capacity		Reach	
											m (ft)	
9.0 m (29.5 ft)	kg								*4,550	*4,550	4.46	
	lb								*10,030	*10,030	(14.6)	
7.5 m (24.6 ft)	kg		*6,200	*6,200	*5,300	*5,300			*3,630	*3,630	6.32	
	lb		*13,670	*13,670	*11,680	*11,680			*8,000	*8,000	(20.7)	
6.0 m (19.7 ft)	kg		*6,430	*6,430	*5,760	5,560			*3,300	*3,300	7.43	
	lb		*14,180	*14,180	*12,700	12,260			*7,280	*7,280	(24.4)	
4.5 m (14.8 ft)	kg	*10,530	*10,530	*8,050	*8,050	*6,090	5,370	*4,920	3,730	*3,180	*3,180	8.11
	lb	*23,210	*23,210	*17,750	*17,750	*13,430	11,840	*10,850	8,220	*7,010	*7,010	(26.6)
3.0 m (9.8 ft)	kg		*10,100	7,820	*6,730	5,080	*5,130	3,610	*3,200	2,950	8.47	
	lb		*22,270	17,240	*14,840	11,200	*11,310	7,960	*7,050	6,500	(27.8)	
1.5 m (4.9 ft)	kg		*11,830	7,210	*7,620	4,800	*5,440	3,470	*3,350	2,840	8.55	
	lb		*26,080	15,900	*16,800	10,580	*11,990	7,650	*7,390	6,260	(28.1)	
Ground Line	kg		11,830	6,880	7,480	4,590	5,370	3,370	*3,640	2,890	8.36	
	lb		26,080	15,170	16,490	10,120	11,840	7,430	*8,020	6,370	(27.4)	
-1.5 m (-4.9 ft)	kg	*11,710	*11,710	*10,960	6,790	7,380	4,510	5,340	3,340	*4,180	3,140	7.88
	lb	*25,820	*25,820	*24,160	14,970	16,270	9,940	11,770	7,360	*9,220	6,920	(25.9)
-3.0 m (-9.8 ft)	kg	*11,250	*11,250	*8,920	6,870	*6,680	4,560			*4,770	3,710	7.05
	lb	*24,800	*24,800	*19,670	15,150	*14,730	10,050			*10,520	8,180	(23.1)

1. Lifting capacity is based on SAE J1097 and ISO 10567.

2. Lifting capacity of the HX series does not exceed 75% of tipping load with the machine on firm, level ground or 87% of full hydraulic capacity.

3. The load point is a hook located on the back of the bucket.





















4. (*) indicates load limited by hydraulic capacity.

LIFTING CAPACITY

 Rating over-front  Rating over-side or 360 degrees

HX220AL HIGH WALKER

8.20 m (26' 11") boom, 6.30 m (20' 8") arm equipped with 800 mm triple grouser shoe.

Load point height m (ft)	Load radius																		At max. Reach			
	1.5 m (4.9 ft)		3.0 m (9.8 ft)		4.5 m (14.8 ft)		6.0 m (19.7 ft)		7.5 m (24.6 ft)		9.0 m (29.5 ft)		10.5 m (34.4 ft)		12.0 m (39.4 ft)		13.5 m (44.3 ft)		Capacity	Reach		
																					m (ft)	
10.5 m (34.4 ft)	kg													*1,280	*1,280					*860	*860	11.04
	lb													*2,820	*2,820					*1,900	*1,900	(36.2)
9.0 m (29.5 ft)	kg															*880	*880			*810	*810	12.06
	lb															*1,940	*1,940			*1,790	*1,790	(39.6)
7.5 m (24.6 ft)	kg													*1,880	*1,880	*1,470	*1,470			*790	*790	12.82
	lb													*4,140	*4,140	*3,240	*3,240			*1,740	*1,740	(42.1)
6.0 m (19.7 ft)	kg													*2,010	*2,010	*1,820	*1,820			*790	*790	13.38
	lb													*4,430	*4,430	*4,010	*4,010			*1,740	*1,740	(43.9)
4.5 m (14.8 ft)	kg											*2,330	*2,330	*2,200	*2,200	*2,120	*2,120	*1,090	*1,090	*800	*800	13.74
	lb											*5,140	*5,140	*4,850	*4,850	*4,670	*4,670	*2,400	*2,400	*1,760	*1,760	(45.1)
3.0 m (9.8 ft)	kg						*3,680	*3,680	*3,050	*3,050	*2,670	*2,670	*2,430	*2,430	*2,270	2,110	*1,360	*1,360	*830	*830	13.93	
	lb						*8,110	*8,110	*6,720	*6,720	*5,890	*5,890	*5,360	*5,360	*5,000	4,650	*3,000	*3,000	*1,830	*1,830	(45.7)	
1.5 m (4.9 ft)	kg			*2,610	*2,610	*6,530	*6,530	*4,580	*4,580	*3,610	*3,610	*3,040	*3,040	*2,670	2,530	*2,430	2,020	*1,490	*1,490	*880	*880	13.96
	lb			*5,750	*5,750	*14,400	*14,400	*10,100	*10,100	*7,960	*7,960	*6,700	*6,700	*5,890	5,580	*5,360	4,450	*3,280	*3,280	*1,940	*1,940	(45.8)
Ground Line	kg			*2,460	*2,460	*6,060	*6,060	*5,350	*5,350	*4,110	3,890	*3,380	3,010	*2,910	2,390	*2,600	1,940	*1,450	*1,450	*960	*960	13.83
	lb			*5,420	*5,420	*13,360	*13,360	*11,790	8,580	*9,060	8,580	*7,450	6,640	*6,420	5,270	*5,730	4,280	*3,200	*3,200	*2,120	*2,120	(45.4)
-1.5 m (-4.9 ft)	kg	*2,110	*2,110	*3,080	*3,080	*5,620	*5,620	*5,890	3,670	*4,510	3,670	*3,670	2,860	*3,120	2,290	*2,730	1,870	*1,100	*1,100	*1,060	*1,060	13.52
	lb	*4,650	*4,650	*6,790	*6,790	*12,390	*12,390	*12,990	8,090	*9,940	8,090	*8,090	6,310	*6,880	5,050	*6,020	4,120	*2,430	*2,430	*2,340	*2,340	(44.4)
-3.0 m (-9.8 ft)	kg	*2,990	*2,990	*3,930	*3,930	*6,160	*6,160	*6,200	3,530	*4,770	3,530	*3,870	2,760	*3,260	2,220	*2,820	1,830			*1,210	*1,210	13.03
	lb	*6,590	*6,590	*8,660	*8,660	*13,580	*13,580	*13,670	7,780	*10,520	7,780	*8,530	6,080	*7,190	4,890	*6,220	4,030			*2,670	*2,670	(42.8)
-4.5 m (-14.8 ft)	kg	*3,920	*3,920	*4,940	*4,940	*7,180	7,160	*6,290	3,470	*4,890	3,470	*3,970	2,710	*3,320	2,190	*2,210	1,830			*1,430	*1,430	12.35
	lb	*8,640	*8,640	*10,890	*10,890	*15,830	15,790	*13,870	7,650	*10,780	7,650	*8,750	5,970	*7,320	4,830	*4,870	4,030			*3,150	*3,150	(40.5)
-6.0 m (-19.7 ft)	kg	*4,950	*4,950	*6,150	*6,150	*8,280	7,270	*6,160	3,490	*4,830	3,490	*3,920	2,720	*3,230	2,220					*1,780	*1,780	11.42
	lb	*10,910	*10,910	*13,560	*13,560	*18,250	16,030	*13,580	7,690	*10,650	7,690	*8,640	6,000	*7,120	4,890					*3,920	*3,920	(37.5)
-7.5 m (-24.6 ft)	kg	*6,110	*6,110	*7,630	*7,630	7,480	*5,760	3,570	*4,540	3,570	*3,640	2,800								*2,410	2,400	10.19
	lb	*13,470	*13,470	*16,820	*16,820	16,490	*12,700	7,870	*10,010	7,870	*8,020	6,170								*5,310	5,290	(33.4)
-9.0 m (-29.5 ft)	kg			*9,180	*9,180	*6,510	*6,510	*4,960	*4,960	*3,850	3,760									*3,190	*3,190	8.51
	lb			*20,240	*20,240	*14,350	*14,350	*10,930	*10,930	*8,490	8,290									*7,030	*7,030	(27.9)
-10.5 m (-34.4 ft)	kg																					
	lb																					











- Lifting capacity is based on SAE J1097 and ISO 10567.
- Lifting capacity of the HX series does not exceed 75% of tipping load with the machine on firm, level ground or 87% of full hydraulic capacity.
- The load point is a hook located on the back of the bucket.
- (*) indicates load limited by hydraulic capacity.

LIFTING CAPACITY











 Rating over-front  Rating over-side or 360 degrees

HX220AL HIGH WALKER

5.68 m (18' 8") Mono boom, 2.00 m (6' 7") arm equipped with 600 mm (24") triple grouser shoe.

Load point height m (ft)	Load radius								At max. Reach		
	3.0 m (9.8 ft)		4.5 m (14.8 ft)		6.0 m (19.7 ft)		7.5 m (24.6 ft)		Capacity		Reach m (ft)
											
7.5 m (24.6 ft)	kg								*5,670	*5,670	5.23
	lb								*12,500	*12,500	(17.1)
6.0 m (19.7 ft)	kg				*5,470	*5,470			*5,530	5,060	6.48
	lb				*12,060	*12,060			*12,190	11,160	(21.3)
4.5 m (14.8 ft)	kg		*7,120	*7,120	*5,900	5,600			*5,580	4,220	7.21
	lb		*15,700	*15,700	*13,010	12,350			*12,300	9,300	(23.7)
3.0 m (9.8 ft)	kg		*8,930	8,030	*6,650	5,370	*5,740	3,900	*5,720	3,840	7.58
	lb		*19,690	17,700	*14,660	11,840	*12,650	8,600	*12,610	8,470	(24.9)
1.5 m (4.9 ft)	kg				*7,340	5,170	5,910	3,820	5,760	3,730	7.63
	lb				*16,180	11,400	13,030	8,420	12,700	8,220	(25.0)
Ground Line	kg		*10,520	7,550	*7,710	5,070			6,010	3,870	7.37
	lb		*23,190	16,640	*17,000	11,180			13,250	8,530	(24.2)
-1.5 m (-4.9 ft)	kg	*12,400	*12,400	*10,130	7,580	*7,550	5,070		*6,470	4,340	6.78
	lb	*27,340	*27,340	*22,330	16,710	*16,640	11,180		*14,260	9,570	(22.2)
-3.0 m (-9.8 ft)	kg	*12,040	*12,040	*8,890	7,730				*6,690	5,540	5.73
	lb	*26,540	*26,540	*19,600	17,040				*14,750	12,210	(18.8)
-4.5 m (-14.8 ft)	kg										
	lb										

5.68 m (18' 8") Mono boom, 2.40 m (7' 10") arm equipped with 600 mm (24") triple grouser shoe.

Load point height m (ft)	Load radius								At max. Reach		
	3.0 m (9.8 ft)		4.5 m (14.8 ft)		6.0 m (19.7 ft)		7.5 m (24.6 ft)		Capacity		Reach m (ft)
											
7.5 m (24.6 ft)	kg								*4,990	*4,990	5.79
	lb								*11,000	*11,000	(19.0)
6.0 m (19.7 ft)	kg				*5,040	*5,040			*4,580	4,560	6.94
	lb				*11,110	*11,110			*10,100	10,050	(22.8)
4.5 m (14.8 ft)	kg		*6,570	*6,570	*5,540	*5,540	*5,190	3,980	*4,490	3,870	7.62
	lb		*14,480	*14,480	*12,210	*12,210	*11,440	8,770	*9,900	8,530	(25.0)
3.0 m (9.8 ft)	kg		*8,390	8,120	*6,350	5,390	*5,470	3,900	*4,600	3,550	7.97
	lb		*18,500	17,900	*14,000	11,880	*12,060	8,600	*10,140	7,830	(26.1)
1.5 m (4.9 ft)	kg		*9,850	7,690	*7,120	5,170	*5,830	3,800	*4,920	3,450	8.02
	lb		*21,720	16,950	*15,700	11,400	*12,850	8,380	*10,850	7,610	(26.3)
Ground Line	kg		*10,440	7,510	*7,600	5,040	5,820	3,730	*5,520	3,560	7.78
	lb		*23,020	16,560	*16,760	11,110	12,830	8,220	*12,170	7,850	(25.5)
-1.5 m (-4.9 ft)	kg	*11,820	*11,820	*10,270	7,500	*7,600	5,010		*6,070	3,940	7.22
	lb	*26,060	*26,060	*22,640	16,530	*16,760	11,050		*13,380	8,690	(23.7)
-3.0 m (-9.8 ft)	kg	*12,960	*12,960	*9,300	7,620	*6,760	5,110		*6,330	4,860	6.25
	lb	*28,570	*28,570	*20,500	16,800	*14,900	11,270		*13,960	10,710	(20.5)
-4.5 m (-14.8 ft)	kg										
	lb										

1. Lifting capacity is based on SAE J1097 and ISO 10567.

2. Lifting capacity of the HX series does not exceed 75% of tipping load with the machine on firm, level ground or 87% of full hydraulic capacity.

3. The load point is a hook located on the back of the bucket.

4. (*) indicates load limited by hydraulic capacity.

LIFTING CAPACITY



Rating over-front



Rating over-side or 360 degrees

HX220AL HIGH WALKER

5.68 m (18' 8") Mono boom, 2.92 m (9' 7") arm equipped with 600 mm (24") triple grouser shoe.

Load point height m (ft)	Load radius										At max. Reach			
	1.5 m (4.9 ft)		3.0 m (9.8 ft)		4.5 m (14.8 ft)		6.0 m (19.7 ft)		7.5 m (24.6 ft)		Capacity		Reach	
													m (ft)	
7.5 m (24.6 ft)	kg							*4,490	*4,490			*3,320	*3,320	6.44
	lb							*9,900	*9,900			*7,320	*7,320	(21.1)
6.0 m (19.7 ft)	kg							*4,500	*4,500			*3,080	*3,080	7.49
	lb							*9,920	*9,920			*6,790	*6,790	(24.6)
4.5 m (14.8 ft)	kg							*5,070	*5,070	*4,750	4,010	*3,020	*3,020	8.13
	lb							*11,180	*11,180	*10,470	8,840	*6,660	*6,660	(26.7)
3.0 m (9.8 ft)	kg					*7,670	*7,670	*5,920	5,420	*5,130	3,900	*3,090	*3,090	8.46
	lb					*16,910	*16,910	*13,050	11,950	*11,310	8,600	*6,810	*6,810	(27.2)
1.5 m (4.9 ft)	kg					*9,330	7,740	*6,780	5,170	*5,570	3,770	*3,290	3,140	8.50
	lb					*20,570	17,060	*14,950	11,400	*12,280	8,310	*7,250	6,920	(27.9)
Ground Line	kg			*6,460	*6,460	*10,210	7,480	*7,390	5,000	5,770	3,680	*3,650	3,220	8.28
	lb			*14,240	*14,240	*22,510	16,490	*16,290	11,020	12,720	8,110	*8,050	7,100	(27.2)
-1.5 m (-4.9 ft)	kg	*7,100	*7,100	*11,080	*11,080	*10,330	7,410	*7,580	4,930	5,750	3,660	*4,320	3,510	7.75
	lb	*15,650	*15,650	*24,430	*24,430	*22,770	16,340	*16,710	10,870	12,680	8,070	*9,520	7,740	(25.4)
-3.0 m (-9.8 ft)	kg	*11,800	*11,800	*13,920	*13,920	*9,690	7,480	*7,130	4,980			*5,670	4,190	6.86
	lb	*26,010	*26,010	*30,690	*30,690	*21,360	16,490	*15,720	10,980			*12,500	9,240	(22.5)
-4.5 m (-14.8 ft)	kg			*11,110	*11,110	*7,820	7,730					*6,090	5,970	5.42
	lb			*24,490	*24,490	*17,240	17,040					*13,430	13,160	(17.8)

5.68 m (18' 8") Mono boom, 3.90 m (12' 9") arm equipped with and 600 mm (24") triple grouser shoe.

Load point height m (ft)	Load radius										At max. Reach					
	1.5 m (4.9 ft)		3.0 m (9.8 ft)		4.5 m (14.8 ft)		6.0 m (19.7 ft)		7.5 m (24.6 ft)		9.0 m (29.5 ft)		Capacity		Reach	
															m (ft)	
7.5 m (24.6 ft)	kg									*2,760	*2,760			*2,300	*2,300	7.64
	lb									*6,080	*6,080			*5,070	*5,070	(25.1)
6.0 m (19.7 ft)	kg									*3,690	*3,690			*2,160	*2,160	8.54
	lb									*8,140	*8,140			*4,760	*4,760	(28.0)
4.5 m (14.8 ft)	kg							*4,100	*4,100	*3,970	*3,970	*2,560	*2,560	*2,120	*2,120	9.11
	lb							*9,040	*9,040	*8,750	*8,750	*5,640	*5,640	*4,670	*4,670	(29.9)
3.0 m (9.8 ft)	kg			*9,120	*9,120	*6,160	*6,160	*5,010	*5,010	*4,440	3,890	*3,630	2,900	*2,150	*2,150	9.40
	lb			*20,110	*20,110	*13,580	*13,580	*11,050	*11,050	*9,790	8,580	*8,000	6,390	*4,740	*4,740	(30.8)
1.5 m (4.9 ft)	kg			*7,910	*7,910	*8,080	7,850	*6,000	5,170	*4,990	3,730	*4,110	2,820	*2,270	*2,270	9.44
	lb			*17,440	*17,440	*17,810	17,310	*13,230	11,400	*11,000	8,220	*9,060	6,220	*5,000	*5,000	(31.0)
Ground Line	kg			*7,390	*7,390	*9,450	7,410	*6,820	4,920	*5,470	3,590	*3,760	2,750	*2,480	*2,480	9.23
	lb			*16,290	*16,290	*20,830	16,340	*15,040	10,850	*12,060	7,910	*8,290	6,060	*5,470	*5,470	(30.3)
-1.5 m (-4.9 ft)	kg	*5,820	*5,820	*9,770	*9,770	*10,070	7,210	*7,300	4,780	5,590	3,510			*2,840	2,840	8.77
	lb	*12,830	*12,830	*21,540	*21,540	*22,200	15,900	*16,090	10,540	12,320	7,740			*6,260	6,260	(28.8)
-3.0 m (-9.8 ft)	kg	*8,970	*8,970	*13,670	*13,670	*9,970	7,190	*7,310	4,750	5,600	3,510			*3,500	3,240	7.99
	lb	*19,780	*19,780	*30,140	*30,140	*21,980	15,850	*16,120	10,470	12,350	7,740			*7,720	7,140	(26.2)
-4.5 m (-14.8 ft)	kg	*13,000	*13,000	*13,200	*13,200	*9,020	7,330	*6,540	4,860					*4,940	4,130	6.80
	lb	*28,660	*28,660	*29,100	*29,100	*19,890	16,160	*14,420	10,710					*10,890	9,110	(22.3)
-6.0 m (-19.7 ft)	kg					*6,270	*6,270									
	lb					*13,820	*13,820									

1. Lifting capacity is based on ISO 10567.

2. Lifting capacity of the HX A Series does not exceed 75% of tipping load with the machine on firm, level ground or 87% of full hydraulic capacity.

3. The Lift-point is bucket pivot mounting pin on the arm (without bucket mass).

4. (*) indicates load limited by hydraulic capacity.

ENGINE		STD
Cummins B 6.7 engine / Stage V		●
HYDRAULIC SYSTEM		STD
ELECTRIC POSITIVE FLOW CONTROL (EPFC)		
3-power mode, 2-work mode, user mode		●
Variable power control		●
Pump flow control		●
Attachment mode flow control		●
Engine auto idle		●
Engine auto shutdown control		●
Electronic fan control		●
CABIN & INTERIOR		STD
ISO STANDARD CABIN		
Rise-up type windshield wiper		●
Radio / USB player		●
Handsfree mobile phone system with USB		●
12V power outlet (24V DC to 12V DC converter)		●
Electric horn		●
All-weather steel cab with 360°visibility		●
Safety glass - tempered glass		●
Safety glass - laminated glass, front window & glass		●
Sliding fold-in front window		●
Sliding side window (LH)		●
Lockable door		●
Hot & cool box		●
Storage compartment		●
Ashtray & cigar lighter		●
Transparent cabin roof-cover		●
Sun visor		●
Door and cab locks, one key		●
Mechanical suspension seat with heater		●
Pilot-operated slidable joystick		●
Console box height adjust system		●
AUTOMATIC CLIMATE CONTROL		
Air conditioner & heater		●
Defroster		●
Starting aid (air grid heater) for cold weather		●
CENTRALIZED MONITORING		
8" LCD display		●
Engine speed or trip meter / Accel.		●
Engine coolant temperature gauge		●
Automatic powerboost function		●
Low speed / High speed		●
Auto idle		●
Overload warning device		●
Engine Connected Diagnostics		●
Air filters monitoring		●
ECO gauges		●
Fuel level gauge		●
DEF level gauge		●
Hyd. oil temperature gauge		●
Fuel warmer		●
Clock		●
Cabin lights (Halogen or LED)		●
Cabin front window rain guard		●
SEAT		
Adjustable air suspension seat with heater		●
CABIN FOPS (ISO 10262) LEVEL 2		●
FOPS (Falling object protective structure) ISO 10262 Level 2		●
CABIN ROPS		
ROPS (Roll over protective structures) ISO 1211 7-2		●

SAFETY		STD
Battery master switch		●
Rearview camera		●
AAVM (Advanced Around View Monitoring)		●
Four front working lights (2 boom mounted, 2 front frame mounted)		●
Travel alarm		●
Rear work lamp (Halogen or LED)		●
Beacon lamp (Halogen or LED)		●
Automatic swing brake		●
Boom holding system		●
Arm holding system		●
Safety lock valve for boom cylinder with overload warning device		●
Safety lock valve for arm cylinder		●
Swing lock system		●
Three outside rearview mirror		●
Front guard - wire net		●

OTHER		STD
BOOMS		
5.68 m, 18' 8" Mono		●
5.65 m, 18' 6" 2-Piece		●
8.2 m, 26' 11" Long reach		●
ARMS		
2.0 m, 6' 7"		●
2.4 m, 7' 10"		●
2.92 m, 9' 7"		●
3.9 m, 12' 10"		●
6.3 m, 20' 8" Long reach		●
Removable clean-out dust net for cooler		●
Removable reservoir tank		●
Fuel pre-filter with water separator		●
Fuel warmer		●
Self-diagnostics system		●
Hi-MATE (Remote management system)		●
Batteries (2 × 12 V × 100 AH)		●
Fuel filler pump with automatic stop function (50L/min)		●
Single-acting piping kit (breaker, etc.)		●
Double-acting piping kit (clamshell, etc.)		●
Rotating Piping Kit		●
Quick coupler piping		●
Quick coupler		●
Engcon tiltrotator		●
Boom floating control		●
One pedal straight travel system		●
Accumulator for lowering work equipment		●
Pattern change valve (2 patterns)		●
Fine swing control system		●
Tool kit		●
Lower frame under cover (Additional)		●
Lower frame under cover (Normal)		●
TRACK SHOES		
Triple grousers shoes (600 mm, 24")		●
Triple grousers shoe (700 mm, 28")		●
Triple grousers shoe (800 mm, 32")		●
Triple grousers shoe (900 mm, 36")		●
Double grousers shoe (700 mm, 28")		●
Track rail guard		●
Full track rail guard		●

* Standard and optional equipment may vary. Contact your Hyundai dealer for more information.

The machine may vary according to International standards.

* The photos may include attachments and optional equipment that are not available in your area.

* Materials and specifications are subject to change without advance notice.

* All imperial measurements rounded off to the nearest pound or inch.

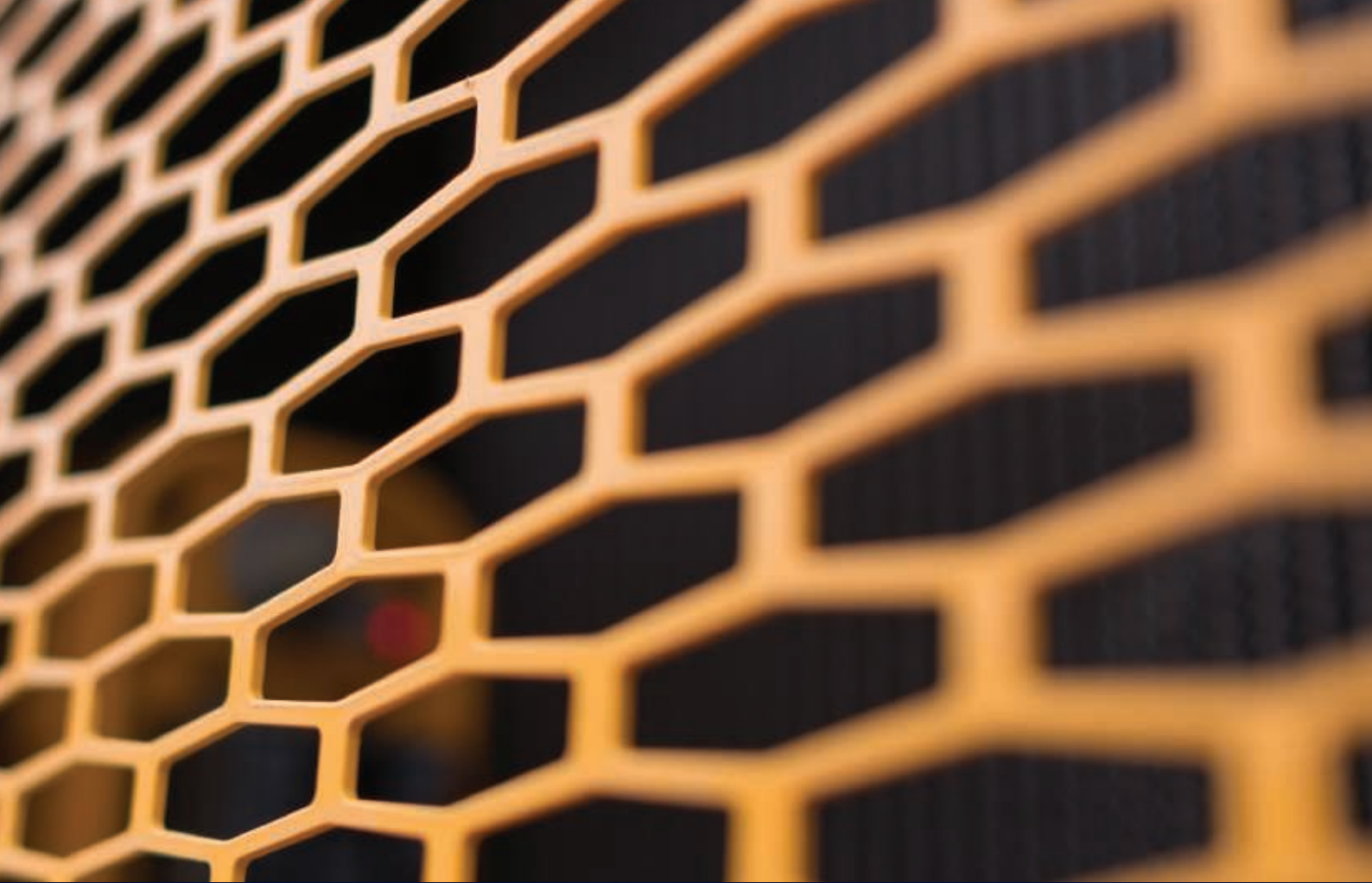

Specifications and design are subject to change without notice. Pictures of Hyundai Construction Equipment Europe products may show other than standard equipment.

Hyundai Construction Equipment Europe nv.
Hyundailaan 4, 3980 Tessenderlo, Belgium.
Tel: (32) 14-56-2200 Fax: (32) 14-59-3405

EN - 2020.03 Rev 1

Ready to experience the Hyundai Effect?

Contact your Hyundai dealer.

hyundai-ce.eu/en/dealer-locator

